

Three-phase autotransformers for dry type neutral generators, finished in anti-flash varnished in IP23 metal enclosure with protection to prevent direct contact with electrical parts.



Technical characteristics

Rating	200 kVA
Input voltage	400 V
Output voltage	NEUTRAL
Frequency	50/60 Hz
Connection group	ZN0
Cover	Metal enclosure RAL 7035 (cat. C3 ISO 12994-2)
Protection degree	IP-23 / IK-08
Cooling	ANAN
Ambient temperature	45 °C
Temperature rise	Class H - 180°C
Insulation	Class H - 180°C
Windings	Class HC - 200 °C
Test voltage	3 kV (1 min, 50 Hz)
Standards	IEC/EN/UNE-EN 60076, CE
Weight	415 kg

Dimensions

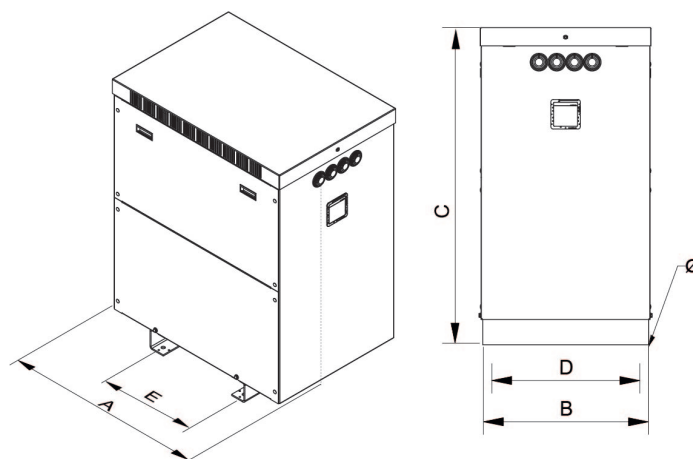

Dimensions (AxBxCxDxE): 795x550x970x500x415 mm 12Ø

Electrical connection

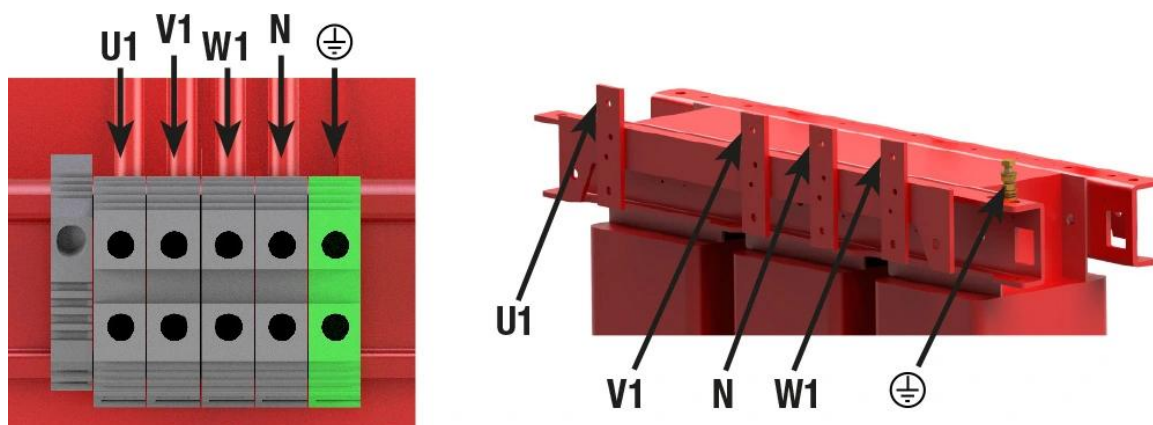

Three-phase autotransformers for dry type neutral generators, finished in anti-flash varnished in IP23 metal enclosure with protection to prevent direct contact with electrical parts.

Features

Dry type autotransformer

Anti-flash varnish finish, offering:

- Protection against corrosive environments
- Increase of electrical isolation
- High compression capacity
- Reduction of noise level
- Increase of product's lifespan

Metalic box IP-23 enclosure painted with epoxy polyester resin RAL 7035 (cat. C2 ISO 12994-2)

Safety class I

Includes stainless steel lifting eyebolts from 16 kVA

Possibility of tailor-made manufacturing

Applications

Downloads
