

Three-phase autotransformers for dry type neutral generator with anti-flash varnish finished for maximum protection, insulation, noise and vibration reduction.



Technical characteristics

Rating	10 kVA
Input voltage	400 V
Output voltage	NEUTRAL
Frequency	50/60 Hz
Connection group	ZN0
Protection degree	IP-00
Cooling	AN
Ambient temperature	45 °C
Temperature rise	Class F - 155°C
Insulation	Class H - 180°C
Windings	Class HC - 200 °C
Test voltage	3 kV (1 min, 50 Hz)
Standards	IEC/EN/UNE-EN 61558, CE
Weight	46 kg

Dimensions

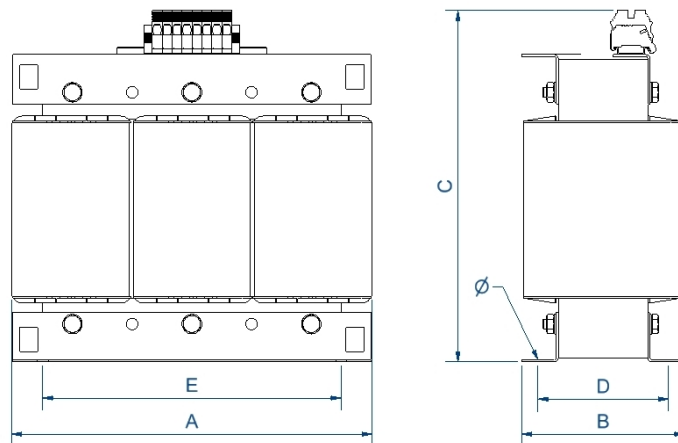

Dimensions (AxBxCxDxE): 360x144x353x114x300 mm 11Ø

Electrical connection

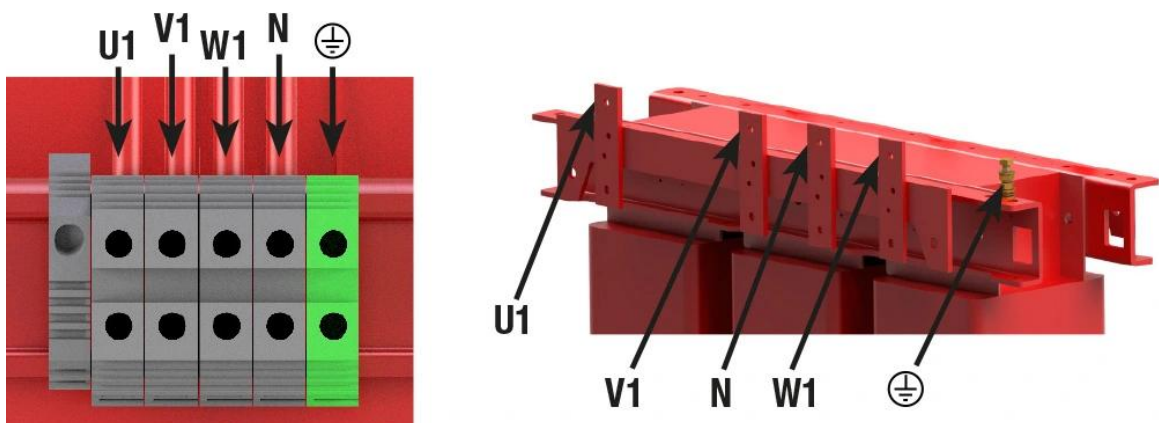

Three-phase autotransformers for dry type neutral generator with anti-flash varnish finished for maximum protection, insulation, noise and vibration reduction.

Features

Dry type autotransformer

Anti-flash varnish finish, offering:

- Protection against corrosive environments
- Increase of electrical isolation
- High compression capacity
- Reduction of noise level
- Increase of product's lifespan

Safety class I

Includes stainless steel lifting eyebolts from 12,5 kVA

Possibility of tailor-made manufacturing

Downloads
