

Non-galvanically isolated homopolar harmonic compensators (3rd, 5th, 7th, 9th, 15th, 17th and 19th) for dry type office installations, finished in anti-flash varnished in IP23 metal enclosure with protection to prevent direct contact with electrical parts.



Technical characteristics

Rating	80 kVA
Line voltage	400 V
Frequency	50/60 Hz
Protection degree	IP-23 / IK-08
Cooling	ANAN
Ambient temperature	45 °C
Temperature rise	Class H - 180°C
Insulation	Class H - 180°C
Windings	Class HC - 200 °C
Test voltage	3 kV (1 min, 50 Hz)
Standards	IEC/EN/UNE-EN 60076 61000-3-2/4, CE y IEE 519, CE
Weight	457 kg

Dimensions

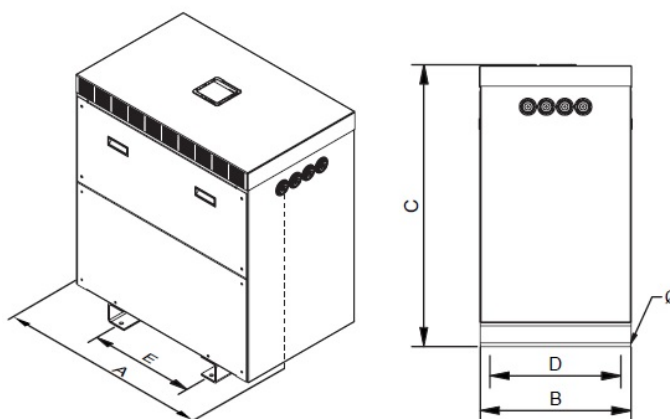

Dimensions (AxBxCxDxE): 795x550x970x500x415 mm 12Ø

Electrical connection

Configuration	With just one C25D-0 or C25D-180	Combination of two C25D-0 and C25D-180	Single C30D
Filtering from load	3rd, 9th and 15th	3rd, 5th, 7th, 9th, 15th, 17th and 19th	3rd, 5th, 7th, 9th, 15th, 17th and 19th
Phase current reduction	15%	45%	45%
THDI reduction	45%	85%	85%
THDV reduction	40%	65%	85%

Non-galvanically isolated homopolar harmonic compensators (3rd, 5th, 7th, 9th, 15th, 17th and 19th) for dry type office installations, finished in anti-flash varnished in IP23 metal enclosure with protection to prevent direct contact with electrical parts.

Features

Compensator

Anti-flash varnish finish, offering:

- Protection against corrosive environments
- Increase of electrical isolation
- High compression capacity
- Reduction of noise level
- Increase of product's lifespan

Metalic box IP-23 enclosure painted with epoxy polyester resin RAL 7035 (cat. C2 ISO 12994-2)

Safety class I

Includes lifting eyebolts

Possibility of tailor-made manufacturing

Technical remarks:

- Install with an impedance adaptor C10D for an effective filtering of homopolar and no homopolar harmonics
- For more information check our compensators' application guide

Downloads
