

Single phase dry type safety transformers, finished in anti-flash varnished in IP20 enclosure, resin filled with protection against direct contact with electrical parts.



Technical characteristics

Rating	1250 VA
Input voltage	230/400/460 V
Output voltage	24/48 V
Frequency	50/60 Hz
Protection degree	IP-20
Cooling	AN
Ambient temperature	45°C
Temperature rise	Class B - 130°C
Insulation	Class H - 180°C
Windings	Class HC - 200 °C
Test voltage	4,6 kV (1 min, 50 Hz) pri-sec - 3,2 kV (1 min, 50 Hz) pri-earth - 2,5 kV (1 min, 50 Hz) sec-earth
Standards	IEC/EN/UNE-EN 61558, CE
Mounting	Screws
Weight	25,6 kg

Electric scheme

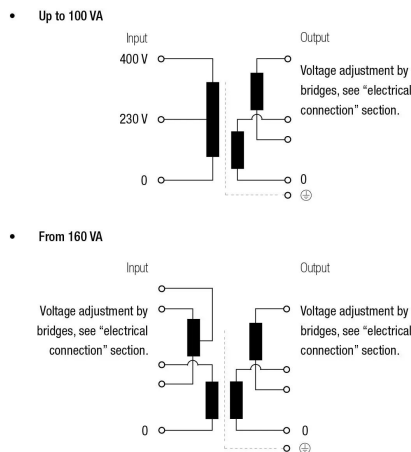

Dimensions

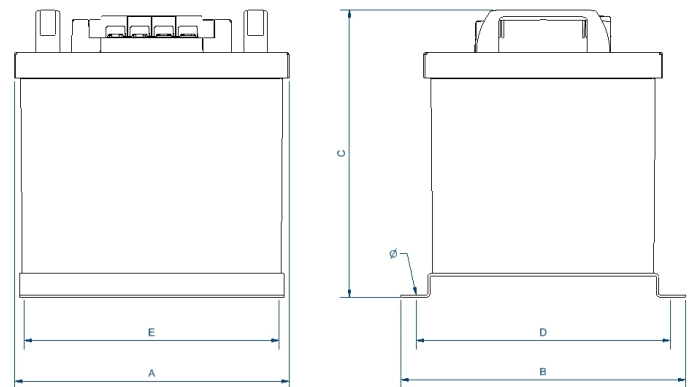

Dimensions (AxBxCxDxE): 233x241x244x219x175 mm 7Ø

Electrical connection



≥ 1250 VA

Input:

230 V

Connection: 1-4
Bridges: 1-2 / 3-4

400 V

Connection: 1-5
Bridges: 2-3

460 V

Connection: 1-4
Bridges: 2-3

Output:

Reference QC 24 V
Reference QD 115 V

Reference QC 48 V
Reference QD 230 V

Connection: 7-10
Bridges: 7-8 / 9-10

Connection: 7-10
Bridges: 8-9

Single phase dry type safety transformers, finished in anti-flash varnished in IP20 enclosure, resin filled with protection against direct contact with electrical parts.

Features

Dry type resin cast transformer

Advantages of resin technology:

- Protection against corrosive environments
- Protection against high vibration levels
- Protection against electrodynamic efforts
- Reduction of noise level
- Increase of product's lifespan

IP-20 enclosure:

- Last generation V-0 fireproof polymer box according to UL94 up to 2500 VA
- Polyester resin from 1250 VA

Safety class I, convertible in class II up to 1000 VA

Includes LED functioning indicator

Full power capacity in every connection

Voltage selection through metallic bridges (included)

Possibility of tailor-made manufacturing

Downloads

- Bridge configuration for the series P, Q and N. Rating: 40 -100 VA. [Watch video](#)
- Bridge configuration for the series P, Q and N. Rating 160 - 5000 VA. [Watch video](#)
- [Obtaining a neutral - Bridge configuration QB \(PH+N output\).](#)
- [P and Q series User's Manual](#)
- [CE Certificate.](#)