

Three-phase reactors for harmonic filtering at the converter output with bimetal overtemperature protection, finished with resin and anti-flash varnished.

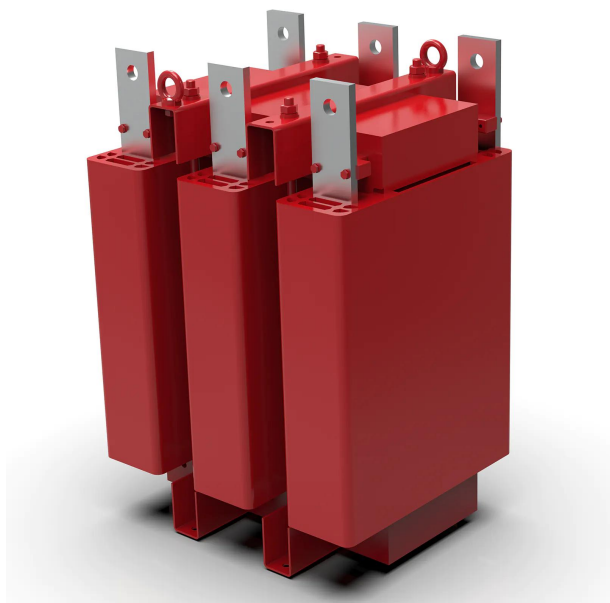

Technical characteristics

Rated current	4 A
Motor rating	1,1 kW / 1,5 CV
Line voltage	380 - 460 V
Reactor	5,513 mH (50 Hz)
Voltage drop	3% (50 Hz)
Thermal overload factor	0,05
Frequency	50/60 Hz
Protection degree	IP-00
Cooling	AN
Ambient temperature	45 °C
Temperature rise	Class F - 155°C
Insulation	Clase H - 180 °C
Windings	Class HC - 200 °C
Test voltage	3 kV (1 min, 50 Hz)
Standards	IEC/EN/UNE-EN 60076-6, CE
Mounting	Screws
Includes	Bimetal thermal protection
Weight	3,2 kg

Electric scheme

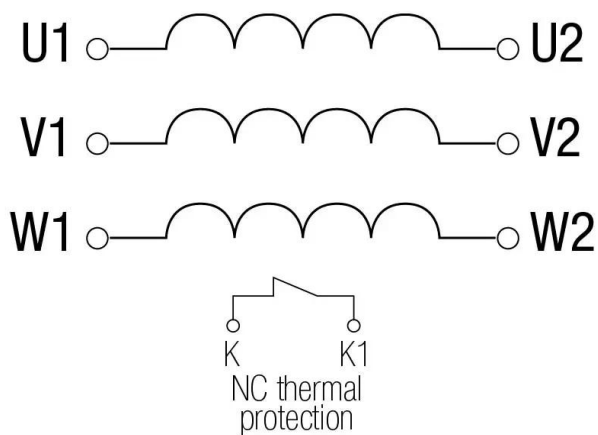

Dimensions

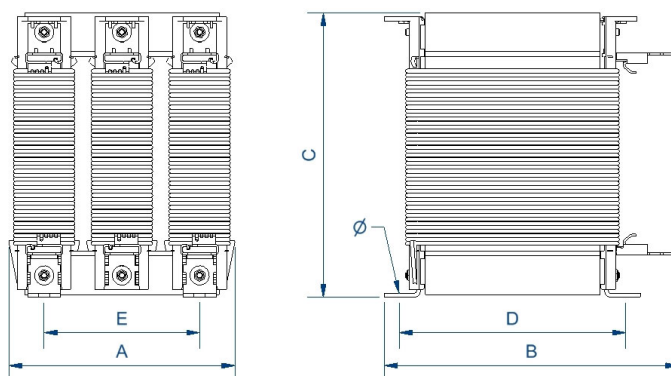

Dimensions (AxBxCxDxE): 150x120x185x59x100 mm 6Ø

Three-phase reactors for harmonic filtering at the converter output with bimetal overtemperature protection, finished with resin and anti-flash varnished.

Features

Reactor

Anti-flash varnish finish, offering:

- Protection against corrosive environments
- Increase of electrical isolation
- High compression capacity
- Reduction of noise level
- Increase of product's lifespan

Safety class I

Includes thermal protection against overtemperatures

Possibility of tailor-made manufacturing

Technical remarks about the use of line reactors:

- Attenuation of voltage peaks in the output of the converter, protecting against premature degradation of the dielectrical parts of the motor
- Reduction of the reflection effect due to the length of the cables between the converter and the motor. This effect amplifies voltage values in the terminals of the motor
- It is recommended to use these inductances for lengths over 50 m from the converter to the motor

Downloads
