

Single-phase dry type cast resin isolation transformers for medical use under IEC/EN 61558-2-15 standard for high corrosion and vibration environments.



Technical characteristics

Rating	6300 VA
Input voltage	230 V
Output voltage	115-0-115 V
Frequency	50/60 Hz
Protection degree	IP-20
Cooling	AN
Ambient temperature	45 °C
Inrush current	< 8In
Temperature rise	Class F - 155°C
Insulation	Class H - 180°C
Windings	Class HC - 200 °C
Test voltage	3,5 kV (1 min, 50 Hz)
No load voltage	< 3 %
Leakage current	0,5 mA (sec-earth)
Standards	IEC/EN/UNE-EN 61558-2-15, CE
Includes	Electrostatic screen between 1º & 2º and bimetal thermal protection
Weight	49,2 kg

Electric scheme

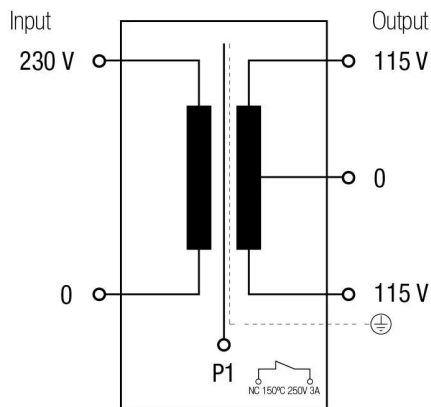

*Klixon 150°C 250 V 3 A included

Dimensions

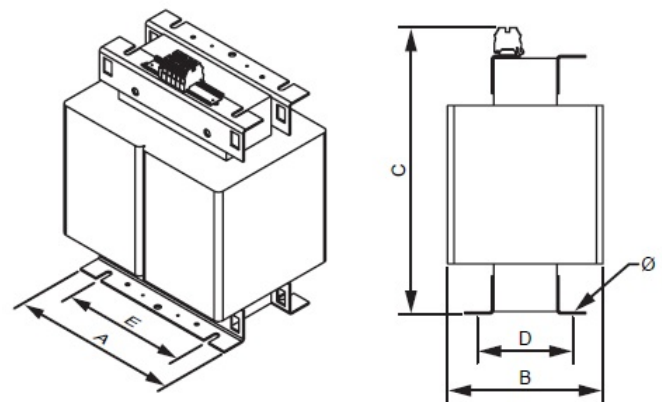

Dimensions (AxBxCxDxE): 280x190x405x126x210 mm 9Ø

Electrical connection

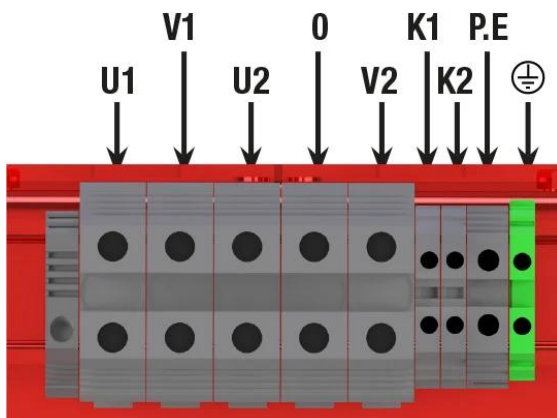

- U1 = 0
- V1 = 230 V
- U2 = 115 V
- V2 = 115 V
- K1 = termostato klixon 150°C para 1ª bobina
- K2 = termostato klixon 150°C para 2ª bobina
- P.E = electrostatic shield

Single-phase dry type cast resin isolation transformers for medical use under IEC/EN 61558-2-15 standard for high corrosion and vibration environments.

Features

Dry type resin cast transformer

Advantages of resin technology:

- Protection against corrosive environments
- Protection against high vibration levels
- Protection against electrodynamic efforts
- Reduction of noise level
- Increase of product's lifespan

Safety class I

Includes electrostatic screen between primary and secondary terminals and bimetallic temperature sensor

Includes also lifting eyebolts from X VA

Possibility of tailor-made manufacturing

Downloads
