

Three-phase isolation transformers for installations with a 60% harmonics rate. Dry type k20 factor with anti-flash varnish finished in IP54/65 metal enclosure with protection for outdoor installation.



Technical characteristics

Rating	20 kVA
Input voltage	400 V
Output voltage	400 V
Frequency	50/60 Hz
k Factor	20
Cover	Metal enclosure RAL 7035 (cat. C4 ISO 12994-2)
THDI (<=)	0,9
Connection group	Dyn11
Protection degree	IP-54 / IK-10
Cooling	ANAF
Ambient temperature	45 °C
Temperature rise	Class H - 180°C
Insulation	Class H - 180°C
Windings	Class HC - 200 °C
Test voltage	3 kV (1 min, 50 Hz)
Standards	IEC/EN/UNE-EN 61558, CE
Weight	247 kg

Dimensions

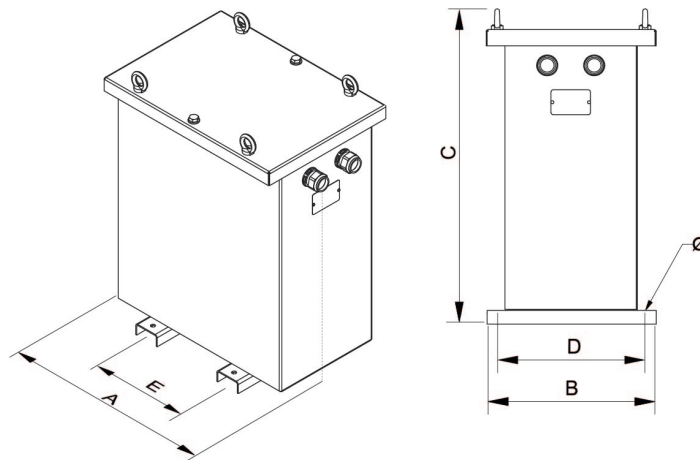

Dimensions (AxBxCxDxE): 890x625x1148x500x426 mm 12Ø

Electrical connection

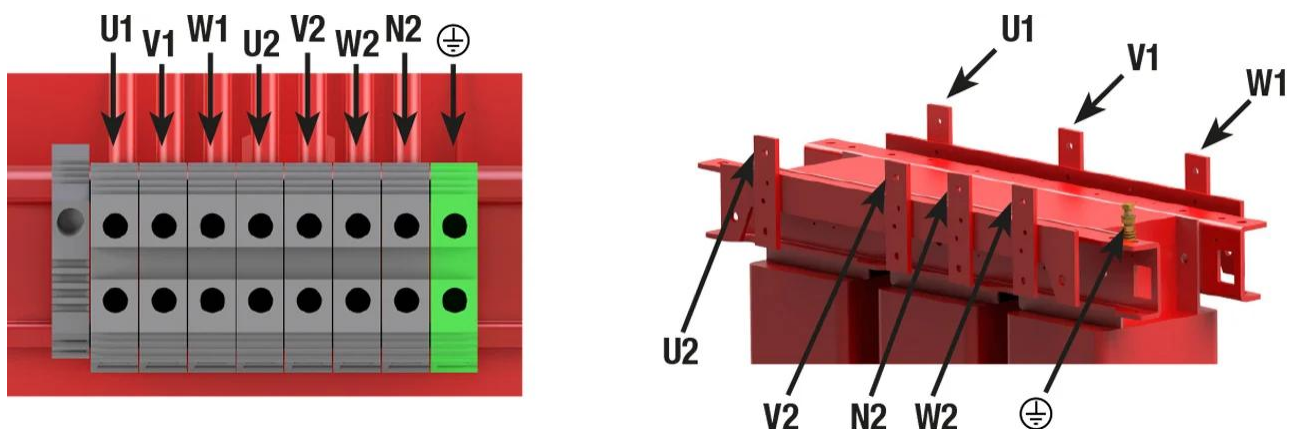

Three-phase isolation transformers for installations with a 60% harmonics rate. Dry type k20 factor with anti-flash varnish finished in IP54/65 metal enclosure with protection for outdoor installation.

Features

Dry type transformer

Anti-flash varnish finish, offering:

- Protection against corrosive environments
- Increase of electrical isolation
- High compression capacity
- Reduction of noise level
- Increase of product's lifespan

IP-65 up to 16 kVA and IP-54 as from 20 kVA (for IP-65 degree consult us) metallic box enclosure painted with polyester resin RAL 7035 (cat. C4 ISO 12994-2)

Safety class I

Neutral sized for $2 \times I_n$

Factor $K = 20$

Includes cable glands, silent-blocks and stainless steel lifting eyebolts

Possibility of tailor-made manufacturing

Downloads
