

Three-phase isolation transformers for installations with a 30% harmonic level. Dry type k13 factor with anti-flash varnish finished in IP54/65 metal enclosure with protection for outdoor installation.



Technical characteristics

Rating	40 kVA
Input voltage	400 V
Output voltage	400 V
Frequency	50/60 Hz
k Factor	13
Cover	Metal enclosure RAL 7035 (cat. C4 ISO 12994-2)
THDI (<=)	0,6
Connection group	Dyn11
Protection degree	IP-54 / IK-10
Cooling	ANAF
Ambient temperature	45 °C
Temperature rise	Class H - 180°C
Insulation	Class H - 180°C
Windings	Class HC - 200 °C
Test voltage	3 kV (1 min, 50 Hz)
Standards	IEC/EN/UNE-EN 60076, CE
Includes	Silent blocks
Weight	319 kg

Dimensions

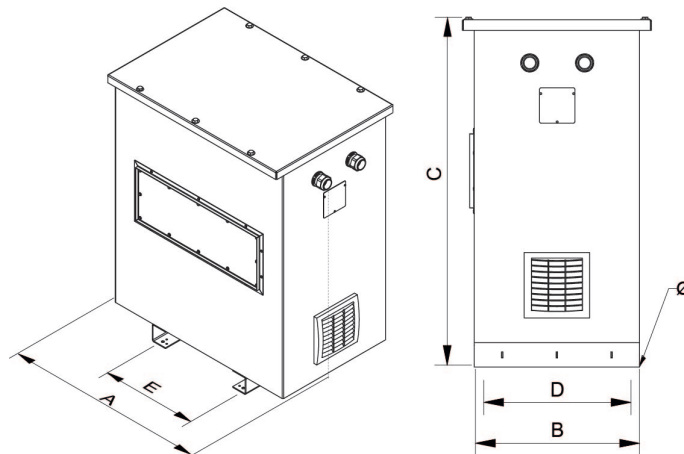

Dimensions (AxBxCxDxE): 970x625x1150x500x426 mm 12Ø

Electrical connection

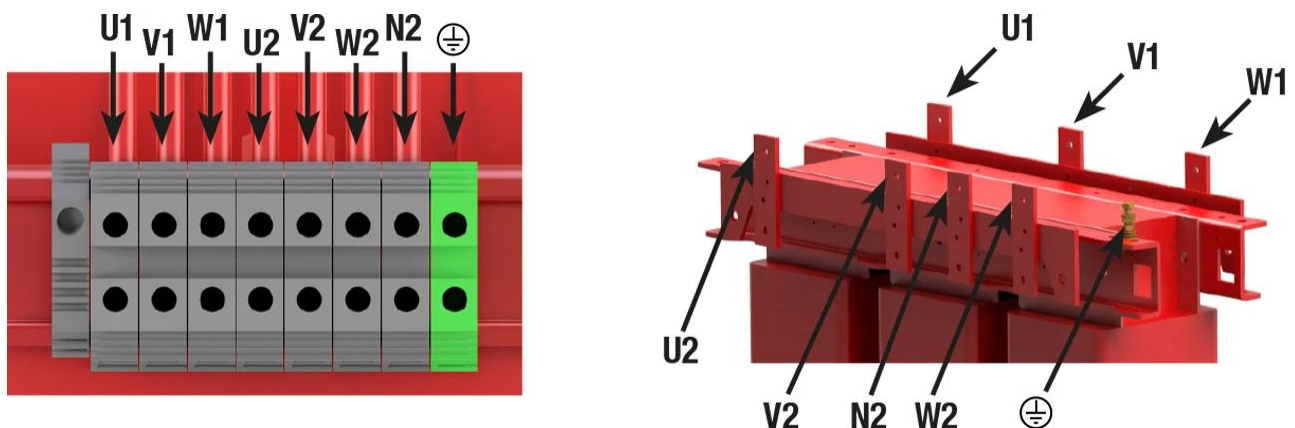

Three-phase isolation transformers for installations with a 30% harmonic level. Dry type k13 factor with anti-flash varnish finished in IP54/65 metal enclosure with protection for outdoor installation.

Features

Dry type transformer

Anti-flash varnish finish, offering:

- Protection against corrosive environments
- Increase of electrical isolation
- High compression capacity
- Reduction of noise level
- Increase of product's lifespan

IP-65 up to 20 kVA and IP-54 as from 25 kVA (for IP-65 degree consult us) metallic box enclosure painted with polyester resin RAL 7035 (cat. C4 ISO 12994-2)

Safety class I

Neutral sized for 2 x In

Factor K = 13

Includes cable glands, silent-blocks and stainless steel lifting eyebolts from 5kVA

Possibility of tailor-made manufacturing

Downloads
