

Three-phase dry type ecological isolation transformers with high performance finished in anti-flash varnished for maximum protection, insulation, noise and vibration reduction.



Technical characteristics

Rating	20 kVA
Input voltage	400 V
Output voltage	400 V
Frequency	50/60 Hz
Connection group	Yyn0
Protection degree	IP-00
Cooling	AN
Ambient temperature	45°C
Temperature rise	Class F - 155°C
Insulation	Class H - 180°C
Windings	Class HC - 200 °C
Inrush current	< 8In
Voltage drop	< 2 %
Efficiency (%)	97,9
Noise level (dB)	< 45
Test voltage	3 kV (1 min, 50 Hz)
Standards	IEC/EN/UNE-EN 61558, CE
Weight	152 kg

Dimensions

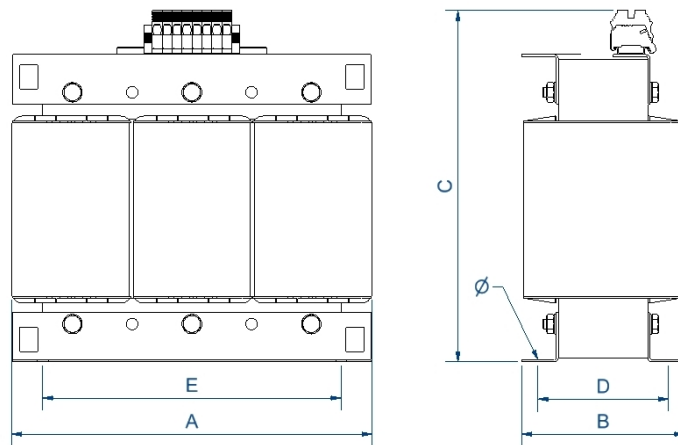

Dimensions (AxBxCxDxE): 480x250x480x144x400 mm 11

Three-phase dry type ecological isolation transformers with high performance finished in anti-flash varnished for maximum protection, insulation, noise and vibration reduction.

Features

Dry type transformer

All transformers are dipped in anti-flash varnish for increased insulation and compactness.

Reduces long-term operating costs.

Low temperature rise.

Longer life than standard transformers.

Prepared for higher ambient temperatures.

Low connection peak.

Lower noise level.

Safety class I

Includes lifting eyebolts

Possibility of tailor-made manufacturing

Applications

- Circuit isolation, with the possibility of increasing or reducing the voltage.
- Reducing voltage drops in installations with long cable lengths. With the installation of a step-up transformer and a step-down transformer.
- In installations with a certain level of electrical noise, the TTG series helps to improve the electrical network quality in secondary.
- Changing the neutral system of an installation
- In installations where energy savings is critical, or where a lower connection peak is required such as renewable energy plants or high energy efficiency installations.

Available accessories

- Protections in primary and secondary.
- One, two and up to 3 electrostatic screens.
- Class II
- Wheels.
- PT100, PTC or Bimetallic probes.
- Painting C5.
- Different RAL.
- Temperature control unit
- Anti condensation system
- Different IP up to IP-65

CE certificate

- **Ecotransformer**