

Three-phase dry type ecological isolation transformers with high performance finished in anti-flash varnished in IP54/65 metal enclosure with protection for outdoor installation.



Technical characteristics

Rating	315 kVA
Input voltage	400 V
Output voltage	400 V
Frequency	50/60 Hz
Connection group	Yyn0
Cover	Metal enclosure RAL 7035 (cat. C4 ISO 12994-2)
Protection degree	IP-54 / IK-10
Cooling	ANAF
Ambient temperature	45°C
Temperature rise	Class H - 180°C
Insulation	Class H - 180°C
Windings	Class HC - 200 °C
Inrush current	< 8In
Voltage drop	< 2 %
Efficiency (%)	98,8
Noise level (dB)	< 65
Test voltage	3 kV (1 min, 50 Hz)
Standards	IEC/EN/UNE-EN 60076, CE
Weight	1282 kg

Dimensions

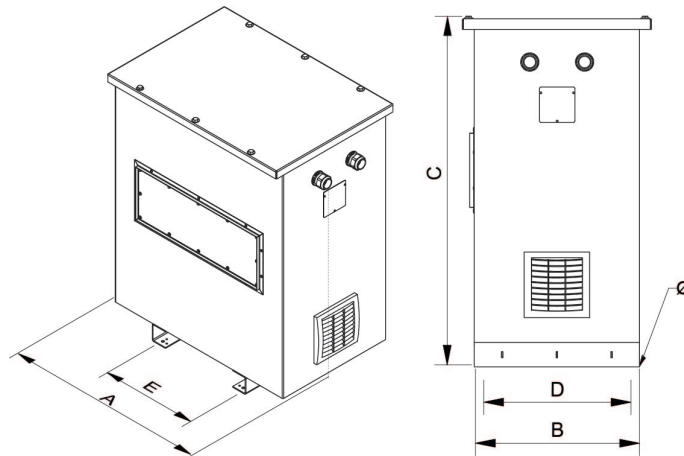

Dimensions (AxBxCxDxE): 1550x1000x1750x806x684 mm 18Ø

Features

Dry type transformer

All transformers are dipped in anti-flash varnish for increased insulation and compactness.

Reduces long-term operating costs.

Low temperature rise.

Longer life than standard transformers.

Prepared for higher ambient temperatures.

Low connection peak.

Lower noise level.

Safety class I.

Includes lifting eyebolts.

Metalic box IP-65 up to 40kVA and IP-54 as from 50kVA (for IP-65 degree consult us) enclosure painted with Polyester resin RAL 7035 (cat. C4 ISO 12994-2).

Possibility of tailor-made manufacturing.

Applications

- Circuit isolation, with the possibility of increasing or reducing the voltage.
- Reducing voltage drops in installations with long cable lengths. With the installation of a step-up transformer and a step-down transformer.
- In installations with a certain level of electrical noise, the TTG series helps to improve the electrical network quality in secondary.
- Changing the neutral system of an installation
- In installations where energy savings is critical, or where a lower connection peak is required such as renewable energy plants or high energy efficiency installations.

Available accessories

- Protections in primary and secondary.
- One, two and up to 3 electrostatic screens.
- Class II
- Wheels.
- PT100, PTC or Bimetallic probes.
- Painting C5.
- Different RAL.
- Temperature control unit
- Anti condensation system
- Different IP up to IP-65

CE certificate

- **Ecotransformer**