

Three-phase to single-phase dry-type isolation finished in anti-flash varnished in IP54/65 metal enclosure with protection for outdoor installation.



Technical characteristics

Rating	5 kVA
Input voltage	400 V
Output voltage	230 V
Frequency	50/60 Hz
Connection group	V/ inV
Protection degree	IP-65 / IK-10
Cover	Metal enclosure RAL 7035 (cat. C4 ISO 12994-2)
Cooling	ANAN
Ambient temperature	45 °C
Temperature rise	Class F - 155°C
Insulation	Class F - 155°C
Windings	Class HC - 200 °C
Test voltage	3 kV (1 min, 50 Hz)
Standards	IEC/EN/UNE-EN 61558, CE
Includes	Silent blocks
Weight	79 kg

Dimensions

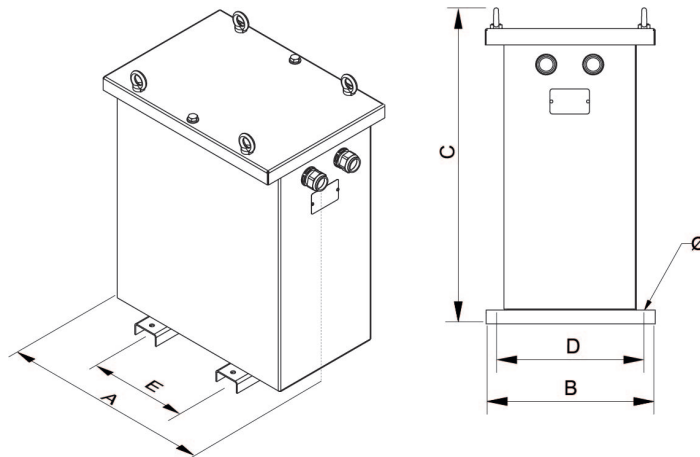

Dimensions (AxBxCxDxE): 510x362x689x320x250 mm 11Ø

Electrical connection

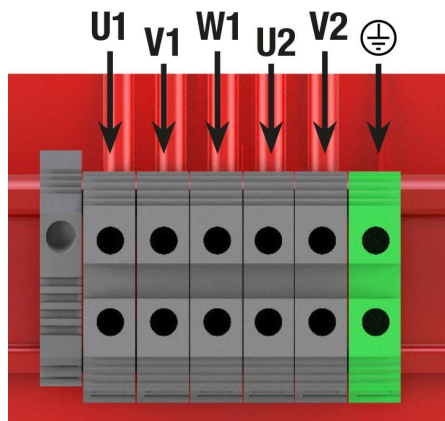

Three-phase to single-phase dry-type isolation finished in anti-flash varnished in IP54/65 metal enclosure with protection for outdoor installation.

Features

Dry type transformer

Dipped in anti-flash varnish and then compacted in the oven. This process increases the insulation grade, reduces noise and provides anti-moisture, waterproofed protection.

Metallic box IP-65 up to 16 kVA and IP-54 as from 20 kVA (for IP-65 degree consult us) enclosure painted with Polyester resin RAL 7035 (cat. C4 ISO 12994-2).

Inverted V/v connection.

Includes lifting eyebolts.

Possibility of tailor-made manufacturing.

Applications

- TTK transformers are used for the galvanic isolation of electrical installations for safety reasons.
- The TTK series with three-phase input and single-phase output are used to achieve a better balance of the primary currents than by connecting only one phase and one neutral of a three-phase line.
- With the three-phase transformer it is also possible to connect a single load of up to half the mains rating.
- In installations where many single-phase loads have to be connected to the same line, the three-phase transformer can also help to make more rating available on that line.

Available accessories

- Protections in primary and secondary.
- One, two and up to 3 electrostatic screens.
- Class II
- Wheels.
- PT100, PTC or Bimetallic probes.
- Painting C5.
- Different RAL.
- Temperature control unit
- Anti condensation system
- Different IP up to IP-65

CE certificate

- **Certificado CE.**