

Three-phase dry type step-up isolation transformers finished in anti-flash varnished in IP23 metal enclosure with protection to prevent direct contact with electrical parts.



Technical characteristics

Rating	63 kVA
Input voltage	230 V
Output voltage	400 V
Frequency	50/60 Hz
Connection group	Dyn11
Cover	Metal enclosure RAL 7035 (cat. C3 ISO 12994-2)
Protection degree	IP-23 / IK-08
Cooling	ANAN
Ambient temperature	45 °C
Temperature rise	Class H - 180°C
Insulation	Class H - 180°C
Windings	Class HC - 200 °C
Efficiency (%)	95,5
Noise level (dB)	< 55
Test voltage	3 kV (1 min, 50 Hz)
Standards	IEC/EN/UNE-EN 60076, CE
Weight	323 kg

Dimensions

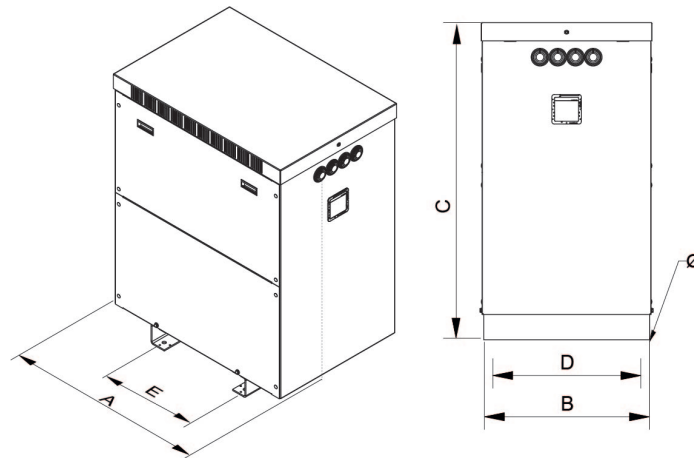

Dimensions (AxBxCxDxE): 795x550x970x500x415 mm 12Ø

Three-phase dry type step-up isolation transformers finished in anti-flash varnished in IP23 metal enclosure with protection to prevent direct contact with electrical parts.

Features

Dry type transformer

Anti-flash varnish finish, offering:

- Protection against corrosive environments
- Increase of electrical isolation
- High compression capacity
- Reduction of noise level
- Increase of product's lifespan

Metalic box IP-23 enclosure painted with Polyester resin RAL 7035 (cat. C3 ISO 12994-2)

Safety class I

Includes lifting eyebolts from >6,3 kVA

Possibility of tailor-made manufacturing

Applications

- TTU transformers are mainly used to isolate circuits, by raising the voltage from 230V to 400V.
- TTU transformers can be used to increase voltage from 230V to 400V
- In installations with a certain level of electrical noise, the TTU series improves the quality of the secondary electrical network.

Available accessories

- Protections in primary and secondary.
- One, two and up to 3 electrostatic screens.
- Class II
- Wheels.
- PT100, PTC or Bimetallic probes.
- Painting C5.
- Different RAL.
- Temperature control unit
- Anti condensation system
- Different IP up to IP-65

CE certificate

- [CE certificate](#).